

1. Remove Shroud.
2. Mount lower section of Track and Unit to hoistway wall and Brackets.
3. Remove Shipping Bracket from Top of Car.
4. Install other track pieces and brackets.
5. Set Header on top end of Track and attach Steel Cable.
6. Make wiring connections at Header.
7. Run lift in up direction (using temporary pendant control) to wind the steel cable onto the drum.
8. Mount Cams on Track.
9. Install Interlocks.
10. Test in Automatic Operation
11. Attach Header Cover and Shroud.

Note:

Summit Lifts, Inc. designs their lifts to meet the stringent requirements of ASME A17.1, and ASME A18.1 when installed properly. Those wishing to acquire these products need to check with local authorities to assure local code compliance, installation requirements, and to determine if permits are required.

Remove Shroud

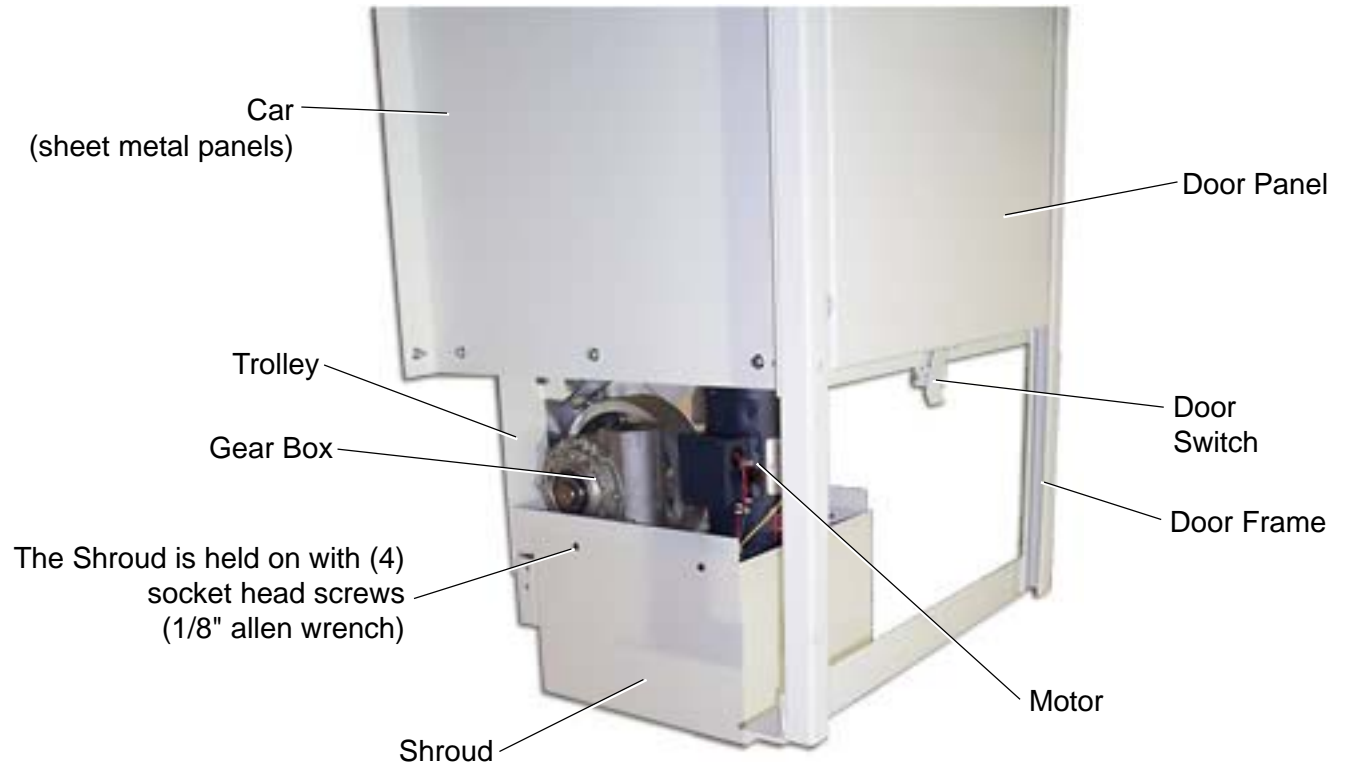

Stand Unit with Track in Hoistway and attach to wall



Stand the assembly up and into place inside the hoistway (*consult the application drawing for proper placement*).

Note: In some applications it may be necessary to remove the car from the trolley.

Bracket attaches to track with 3/8-16 x 3/8" hex head screw and a square nut (inside slot of track)



Attach to wall with #14 x 2" wood screws

Bracket Locations:
-6" from each end of track
-12" from each side of track splice

Tip: The square nuts are held inside the track slots with pieces of foam, **do not** remove the pieces of foam until installation is complete.

Square Nut

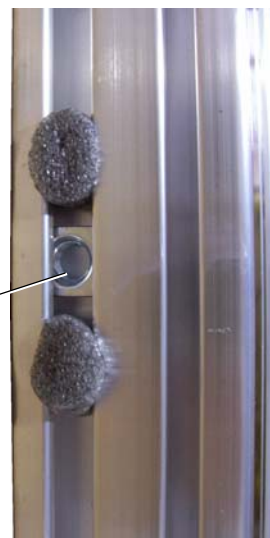

Remove Shipping Bracket from top of Car

3

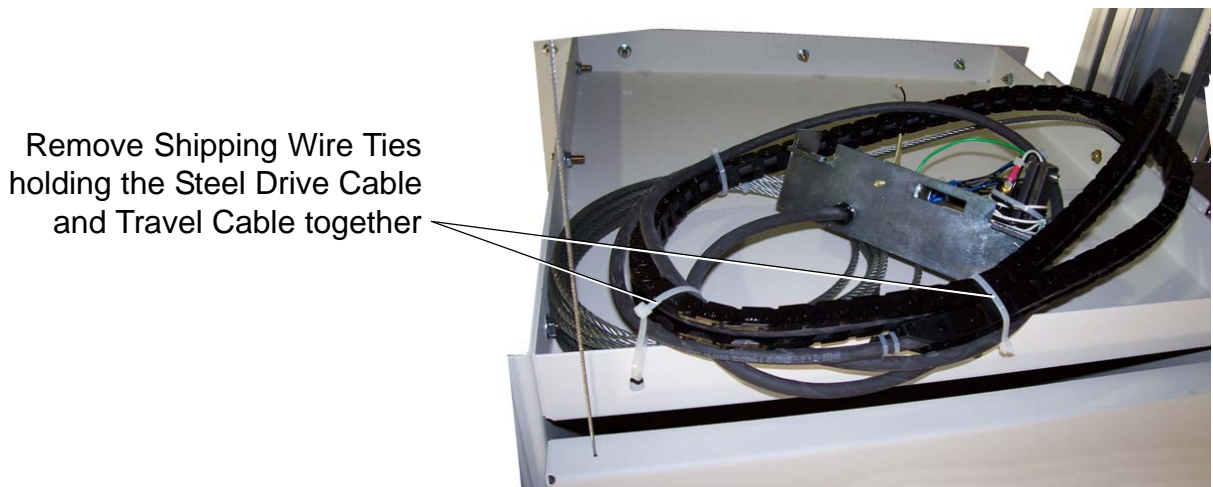

Important

Uncoil the Steel Drive Cable and Travel Cable, ensuring they are not twisted.

Install Other Track Pieces and Brackets

4

Each piece of Track has 3 Splice Bars installed in the lower end. Loosen the set screws (5/32" allen wrench) and slide the bars half way out and re-tighten the set screws.

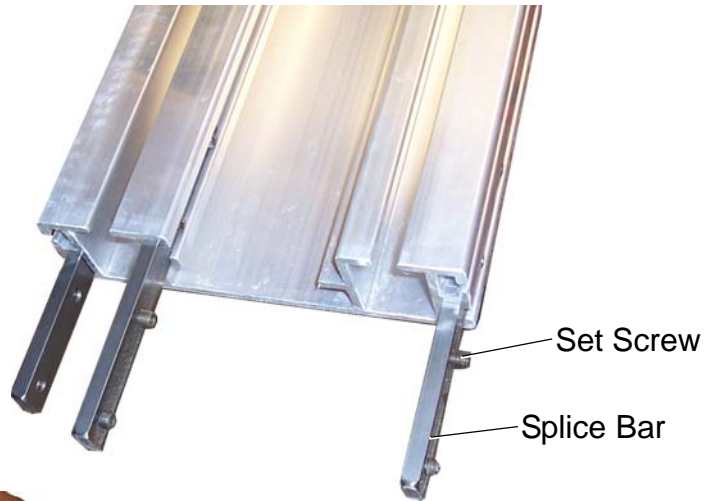

Slide the Track and Splice Bars into the Track mounted to the wall



Tighten all set screws when the track joint is properly aligned



Attach the track to the wall with track brackets



(continued on next page)

4

Install Other Track Pieces and Brackets

continued

For 3-Stop Dumbwaiters only:

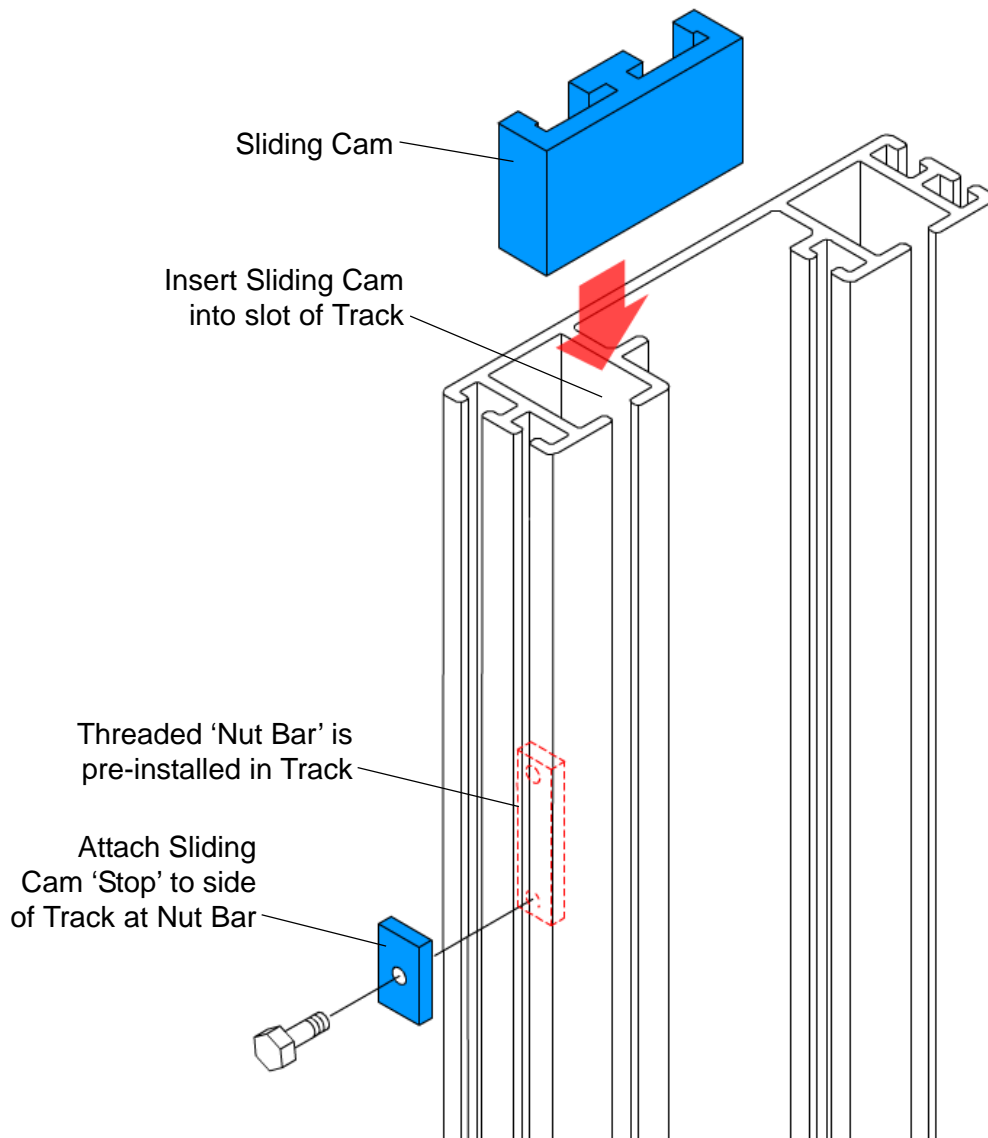

The sliding cam should contact the car top switch when the car is at the middle landing. Final adjustment can be made after the middle landing cam is adjusted.

The sliding cam rides along with the car when the car is at or above the middle landing stop.

The switch tells the controller which direction to run when a middle 'call' is registered.

Set Header on top of Track and attach Steel Cable

5

Header sets on top of the track
(It is not mechanically fastened to the track)

Tapped screw holes are for attaching the Header Cover later in the Installation

The Travel Cable runs down this side of the Track



Insert end of Steel Cable into Header

The Final Limit Switch slides into the top of the track before the header is set in place
(The ultimate location of the switch will be determined later in the installation)

Note: The Final Limit Switch is a safety device that stops the operation of the dumbwaiter if the car should overrun the upper limit. It disables all controls.

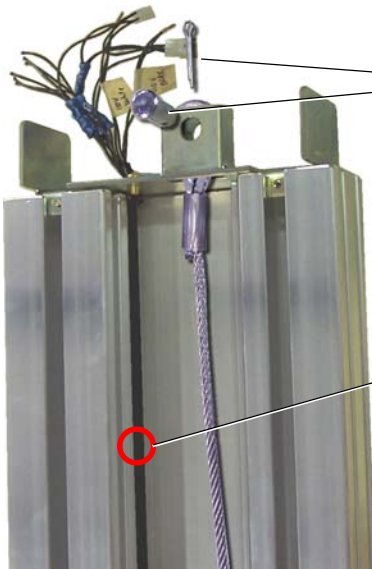

Secure Steel Cable with a clevis pin and cotter pin

Secure Travel Cable inside the Track (above black plastic chain) with adhesive clips. *(adhesive goes against side wall of track)*
Space clips approximately 24" between the plastic chain and track header

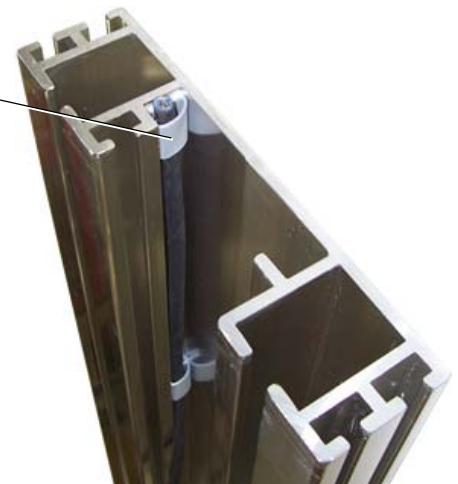

Make Wiring Connections at Header

1. Connect to power.
2. Plug-in Call-Send cables.
3. Plug-in Interlock cables

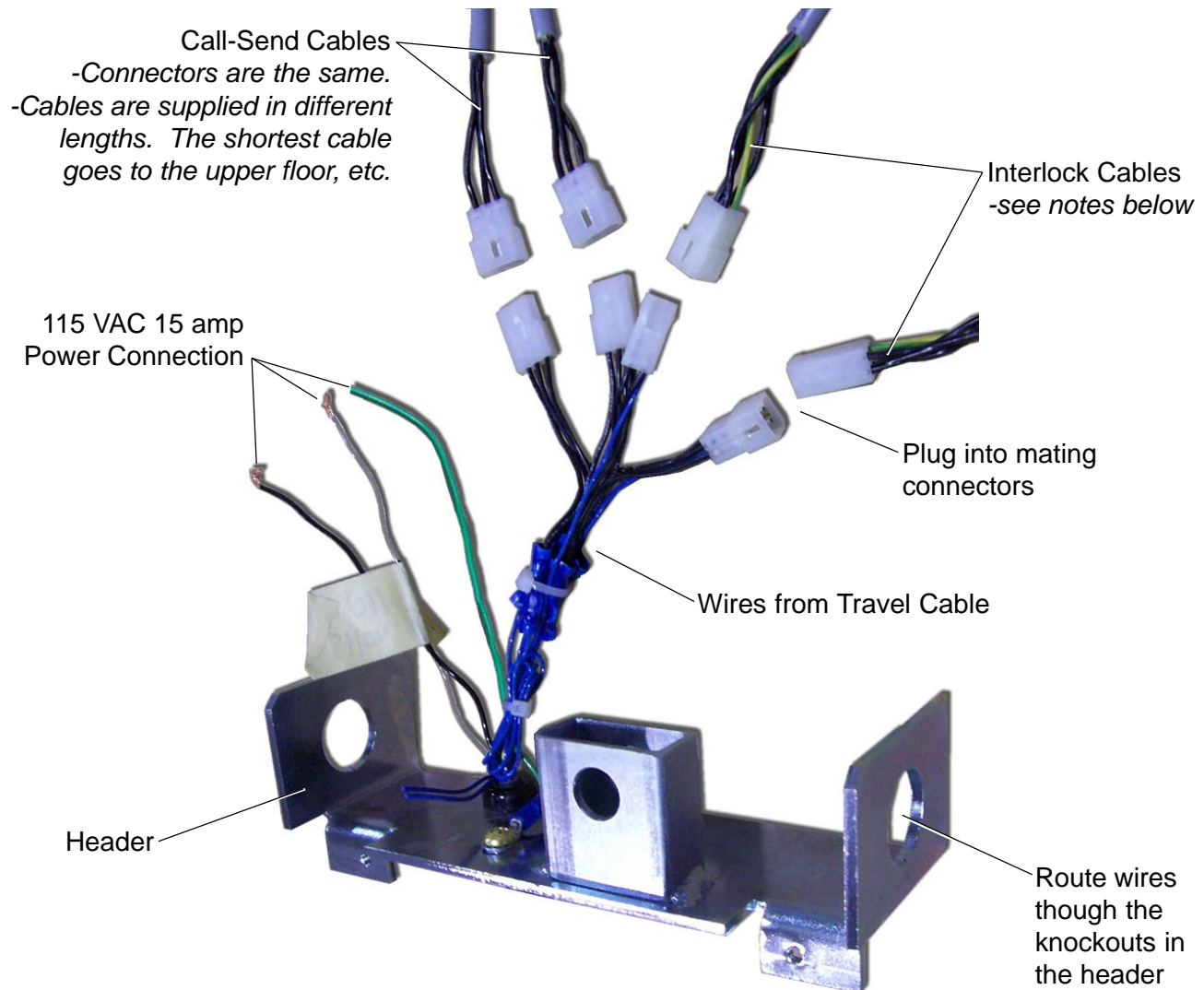

Interlock Cable Note:

The connectors for the interlocks are different to prevent being plugged into the wrong interlock.

The photo to the right shows the orientation of the connectors at the header.



Upper Interlock

Middle Interlock
(3-Stops only)

Lower Interlock

Wind the Steel Cable onto the Cable Drum

7

Run lift in the up direction (using temporary pendant control) to wind the steel cable onto the drum

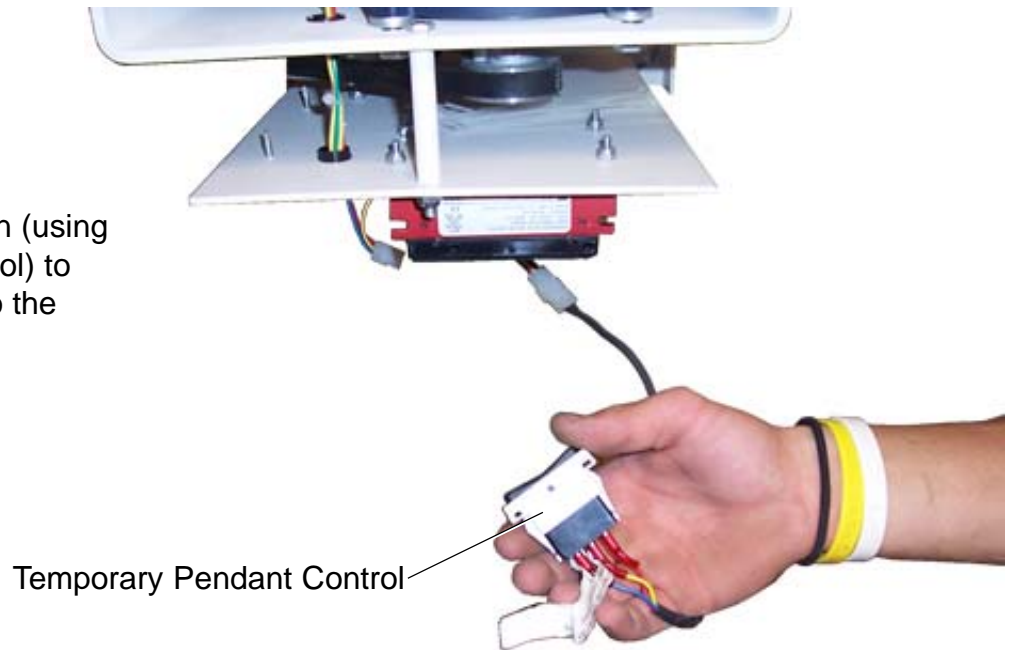

Temporary Pendant Control

Warning!

All Safety Devices (except for the final limit) are bypassed when using the pendant control.

The cable should be wound onto the grooves of the drum. **Ensure that no grooves are skipped or that the cable does not wind over itself.**

Mount Cams on Track

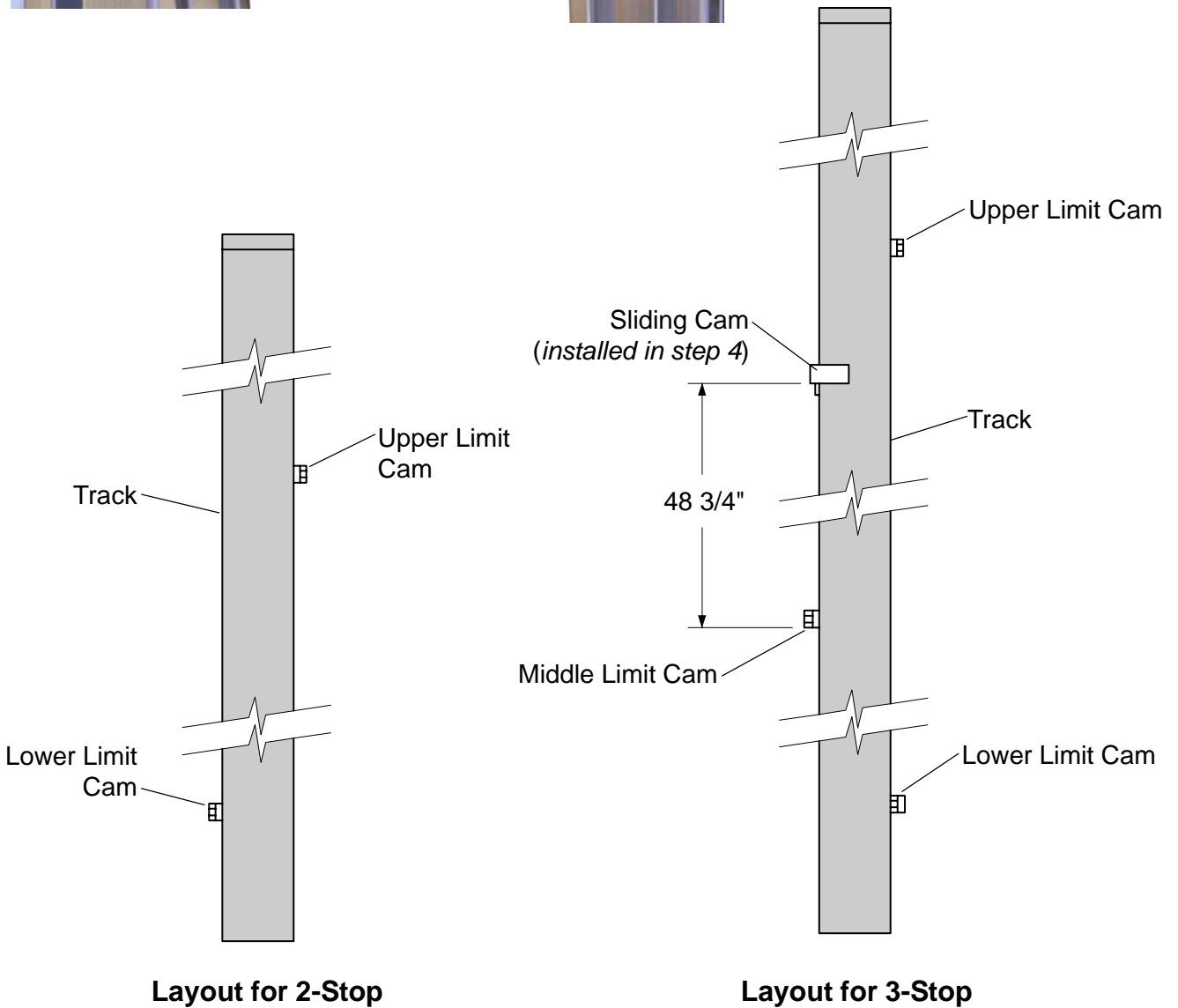
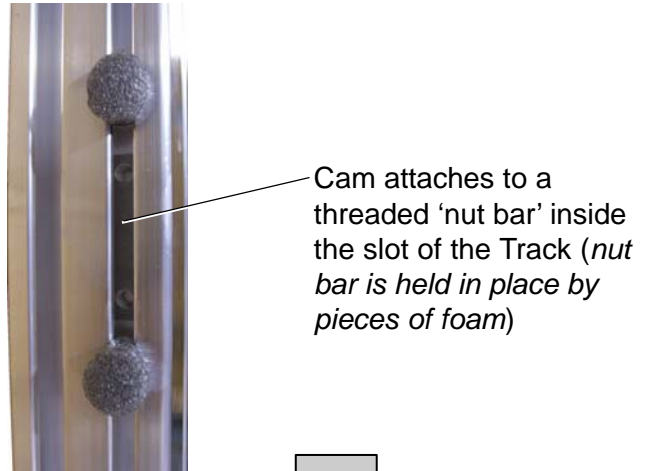
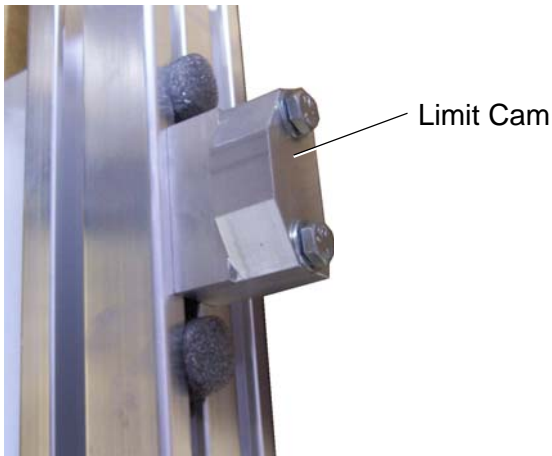

Notes:

- Bottom of the floor limit cams are located approximately 15" below the landing stop.
- Cams can be moved up or down to adjust the stopping position of the car.
- Switches are located on the car.

The G.A.L. interlock prevents the dumbwaiter from operating if a hoistway door is opened. The hoistway door is unlocked mechanically when a cam on the car contacts a lever arm on the interlock.

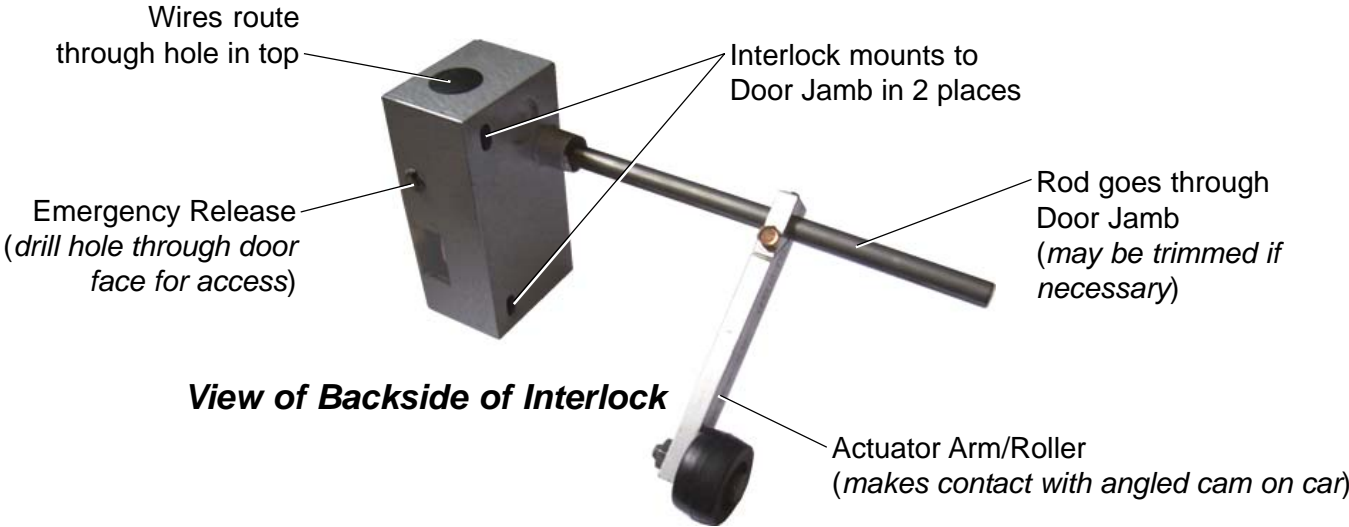

Cut-out hoistway wall as necessary to accommodate Actuator Arm



The Interlock will be located in the upper corner of the doorway, opposite of the door hinges



Face of Interlock to be located between 1/2" and 5/8" off of the inside of the 'closed' hoistway door

9

Install G.A.L. Interlocks

continued

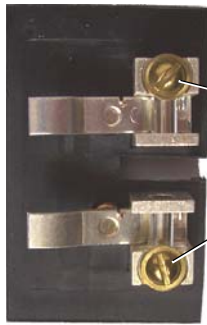

Route the Interlock Cable thru hole in top of Interlock and connect wires #1 and #2 to the terminal block and the green wire to ground

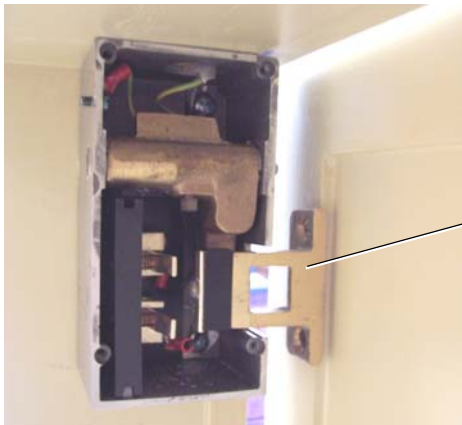

Attach the Keeper to the inside of the hoistway door in alignment with the Interlock

The angle of the Actuator Arm can be adjusted for proper actuation of the Interlock



The Cam on the Car can be adjusted vertically and horizontally

Notes:

- If doors are not installed at the time of the dumbwaiter installation, the door closed switch can be bypassed by twisting wires #1 and #2 together.

WARNING: Only when necessary, this safety circuit should only be bypassed during installation or troubleshooting. The dumbwaiter should never be allowed to be used under any circumstances with a disabled safety device by anyone other than a person that is servicing it whom has the knowledge of the functionality of this safety. Possible risk of injury or death could occur if the safety circuit is bypassed or not functioning properly.

WARNING: If at any time the interlock is found not to be working properly, the lift should immediately be taken out of service until repairs can be made. Failure to do so could lead to the possible risk of injury or death.

The car door(s) and hoistway doors must be closed for the dumbwaiter to run

Test the following items to confirm proper setup of the dumbwaiter:

- Verify each call-send control 'calls' and 'sends' the dumbwaiter to the appropriate landing.
- Verify the floor of the dumbwaiter stops level with the sill at each stop. *Adjust position of cams if necessary.*
- Verify all controls are inoperable if the car door is open.
- Verify all controls are inoperable if a hoistway door is open. *Test each hoistway door individually.*
- Verify each hoistway door locks when the dumbwaiter car is not parked at that landing.
- Verify all controls are inoperable if the final limit switch is actuated.
- Verify all controls are inoperable if the slack cable device switch is opened.
- Travel Cable: Verify that the travel cable properly travels inside the track and adhesive clips are properly installed.
- Hardware: Verify all track mounting hardware, switch cams and car hardware are securely tightened.

Complete the Installation



1. Adjust final limit switch position.
2. Install cover on header.
3. Replace shroud.